

# PRODUCT DATASHEET

## DL ALU DN 200 25 W 4000 K IP44/IP20 WT

DOWNLIGHT ALU | Downlight luminaires with aluminum housing

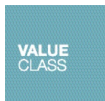

### Areas of application

- Direct replacement for luminaires with compact fluorescent lamps
- General illumination
- Public areas
- Stairways
- Corridors
- Foyers
- Shops

### Product benefits

- High luminous efficacy
- Energy savings up to 60 % (compared to luminaires that use CFL lamps)
- Very homogenous light
- Functional design
- Easy installation with fast connection
- External driver for extended flexibility (compatible with selected DALI drivers)
- 5 years guarantee

### Product features

- Diameter of required ceiling cut-out: 150 mm or 200 mm (depending on version)
- Type of protection: IP44



## TECHNICAL DATA

### Electrical data

Nominal wattage	25.00 W
Nominal voltage	220...240 V
Mains frequency	50...60 Hz
Nominal current	110 mA
Inrush current	7 A
Max. number of luminaires per miniature circuit breaker B16	107
Max. number of luminaires per miniature circuit breaker C10	72
Max. number of luminaires per miniature circuit breaker C16	116
Power factor $\lambda$	> 0.90
Total harmonic distortion	< 20 %
Protection class	II
Operating mode	External LED driver

### Photometrical data

Luminous flux	2370 lm
Luminous efficacy	95 lm/W
Color temperature	4000 K
Light color (designation)	Cool White
Color rendering index Ra	> 80
Standard deviation of color matching	≤6 sdc <sub>m</sub>
Luminous intensity	-
Flickering metric (Pst LM)	-
Stroboscope effect metric (SVM)	-
Photobiological safety group acc. to EN62778	RG0
Photobiological safety group acc. to EN62471	RG0
Beam angle	100 °

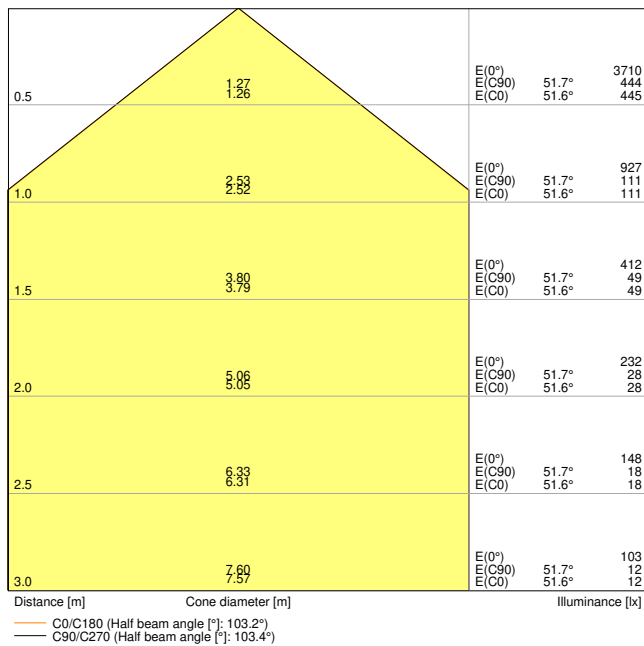

DL ALU DN200 25W 4000K WT IP44

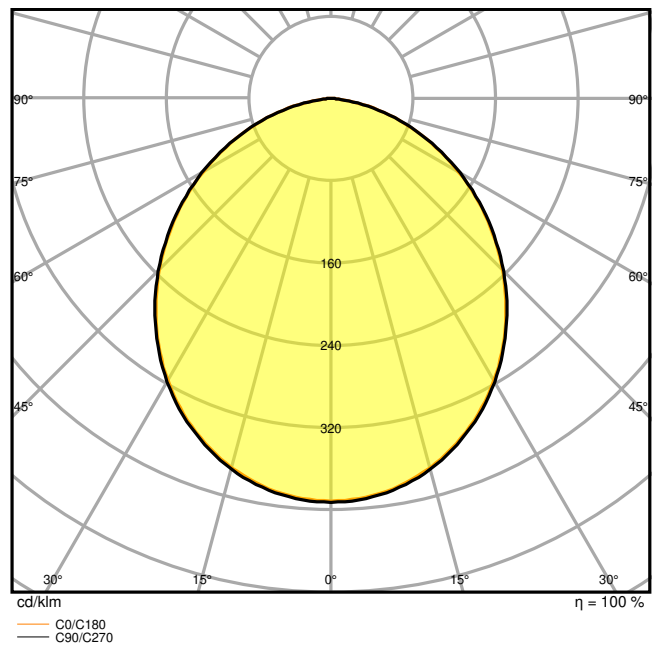

DL ALU 25W4000K WT IP44

### Dimensions & Weight

Diameter	215.00 mm
Height	61.00 mm
Product weight	600.00 g

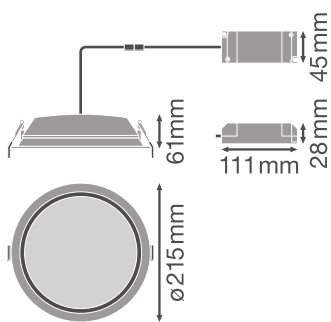

DL ALU DN200

### Materials & Colors

Product color	White
Housing color	White

Body material	Aluminum
Cover material	Polymethylmethacrylate (PMMA)
Glow Wire Test according to IEC 60695-2-12	650 °C

### Application & Mounting

Ambient temperature range	-20...+45 °C
Temperature range at storage	-20...+80 °C
Type of connection	Screw terminal, 2-Pole (L,N)
Type of protection	IP44/IP20
Protection class IK (shock resistance)	IK02
Dimmable	No
Mounting type	Recessed
Mounting location	Ceiling
Application environment	Indoor
Mounting diameter	200 mm
Mounting depth	120 mm
LED module replaceable	Not replaceable
With light source	Yes

### Lifespan

Lifespan L70/B50 at 25 °C	50000 h <sup>1)</sup>
Lifespan L80/B10 at 25 °C	45000 h <sup>1)</sup>
Lifespan L90/B10 at 25 °C	30000 h
Number of switching cycles	100000

<sup>1)</sup> t[h]: L70 / B50 @ 25 °C (Ta), t[h]: L80 / B10 @ 25 °C (Ta), t[h]: L90 / B10 @ 25 °C (Ta)

### Control gear

Output current	550 mA
ECG - Output ripple current	< 30 %
ECG - Length	111 mm
ECG - Width	45 mm
ECG - Height	28 mm

### Certificates & Standards

Standards	CE / CB / ENEC / TÜV SÜD
Luminaire with limited surface temperature, "D sign"	No

Ball shot safe	No
----------------	----







Additional product data





Number of illuminants	Not relevant
-----------------------	--------------



Accessories Optional

Product image	Product name	EAN
	EM CONVERSION BOX	4058075237025



DOWNLOAD DATA

Documents and certificates	Document name
 User Instruction	UI Downlight ALU
 Addon Technical Information	LSI DL ALU
 On-Pack-Info	Legal Insert Downlight LED ALU+Comfort
 Declarations of conformity	CE-Certificate Downlight ALU TUV
 Declarations of conformity	EU Declaration of Conformity DOWNLIGHT ALU LEDV
 Declarations Of Conformity UKCA	UKCA Declaration of Conformity DL ALU WT IP44

Photometric and lighting design files	Document name
 IES file (IES)	DL ALU DN200 25W 4000K WT IP44
 LDT file (Eulumdat)	DL ALU DN200 25W 4000K WT IP44
 ULD file (DIALux)	DOWNLIGHTALU20025W4000KIP44WT
 ROLF file (RELUX)	DL ALU DN200 25W-4000K
 UGR file (UGR table)	DL ALU 25W4000K WT IP44

Photometric and lighting design files		Document name
	LDC typ cone	DL ALU DN200 25W 4000K WT IP44
	LDC typ polar	DL ALU 25W4000K WT IP44

CAD/BIM files		Document name
	BIM_Revit_3D	Downlight ALU
	CAD_STEP_3D	DL ALU 25W 35W

Tender texts		Document name
	Tender documents	DOWNLIGHT ALU 200 25 W 4000 K IP44IP20 WT-EN

**LOGISTICAL DATA**

Product code	Packaging unit (Pieces/Unit)	Dimensions (length x width x height)	Gross weight	Volume
4058075091511	Folding box 1	225 mm x 225 mm x 110 mm	775.00 g	5.57 dm <sup>3</sup>
4058075091528	Shipping box 8	462 mm x 462 mm x 240 mm	7020.00 g	51.23 dm <sup>3</sup>

The mentioned product code describes the smallest quantity unit which can be ordered. One shipping unit can contain one or more single products. When placing an order, for the quantity please enter single or multiples of a shipping unit.

**ADDITIONAL CATALOG INFORMATION**

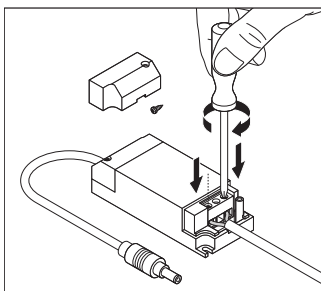

**References / Links**

– For Guarantee see [www.ledvance.com/guarantee](http://www.ledvance.com/guarantee)

**DISCLAIMER**

Subject to change without notice. Errors and omission excepted. Always make sure to use the most recent release.