

PRODUCT DATASHEET

SP CBO ADJ V 5.5W CPS 60DEG IP65 WT

SPOT COMBO ADJUST | Coverable spot with CCT and power select (CPS) in adjustable version



VALUE
CLASS

Areas of application

- Direct replacement for recessed spotlights with halogen lamps
- General illumination
- Hotel rooms and corridors
- Bars, restaurants
- Residential interiors

Product benefits

- White round ring included
- Color temperature adjustment via switch on the back of the spot
- Power select: Brightness adjustment via a switch on the driver
- Coverable with most thermal isolation material according to IEC 60598-2-2
- 5 years guarantee

Product features

- Color temperature switch (CCT): 2700 K, 3000 K, 4000 K
- Power select option available to select between 2 lumen packages
- Type of protection: IP65
- Housing material: polycarbonate (PC)



TECHNICAL DATA

Electrical data

Nominal wattage	5.50 W
Nominal voltage	220...240 V
Mains frequency	50...60 Hz
Nominal current	43.000 mA
Inrush current	8.8 A
Inrush current time T_{h50}	96 μ s
Max. number of luminaires per miniature circuit breaker B16	79
Max. number of luminaires per miniature circuit breaker C10	62
Max. number of luminaires per miniature circuit breaker C16	99
Power factor λ	> 0.5
Protection class	II
Operating mode	Electronic control gear (ECG)

Photometrical data

Luminous flux	600 lm
Luminous efficacy	109 lm/W
Color temperature	2700 K / 3000 K / 4000 K
Light color (designation)	Warm White / Cool White
Color rendering index Ra	> 90
Standard deviation of color matching	< 6 sdc _m
Low flicker	Yes
Flickering metric (Pst LM)	<1
Stroboscope effect metric (SVM)	<0.4
Photobiological safety group acc. to EN62778	RG1
Beam angle	60 °

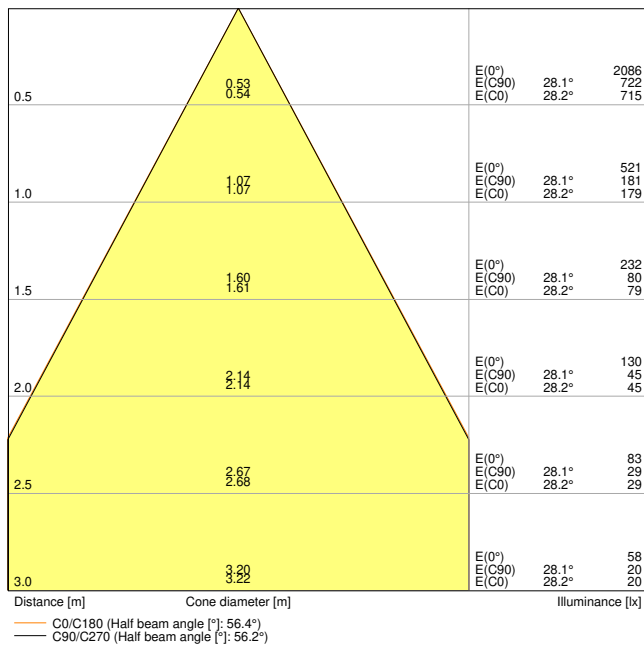

SP CBO ADJ V 3.6W 927

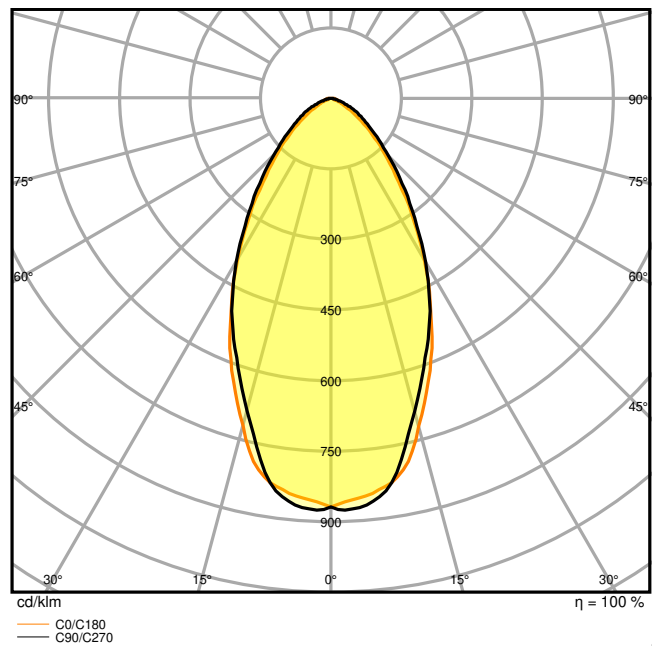

SP CBO ADJ V 3.6W 927

Dimensions & Weight

Diameter	81.50 mm
Height	48.00 mm
Product weight	183.00 g

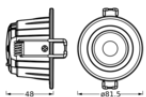

SP ADJ3.6/5.5W927/30/40
60DEGIP65WT

Materials & Colors

Product color	White
Housing color	White
Body material	Polycarbonate (PC)
Cover material	Aluminum
Light emitting surface material	Plastic

Glow Wire Test according to IEC 60695-2-12	850 °C
Mercury content	0.0 mg

Application & Mounting

Ambient temperature range	-20...+40 °C
Temperature range at storage	-20...+80 °C
Type of connection	Push terminal
Type of protection	IP65/IP20
Protection class IK (shock resistance)	IK03
Dimmable	No
Mounting type	Recessed
Mounting location	Ceiling
Application environment	Indoor
Mounting diameter	68 mm
Mounting depth	48 mm
Adjustable	Yes
LED module replaceable	Not replaceable
With light source	Yes

Lifespan

Lifespan L70/B50 at 25 °C	50000 h ¹⁾
Lifespan L80/B10 at 25 °C	39000 h ¹⁾
Lifespan L90/B10 at 25 °C	18000 h
Number of switching cycles	25000

¹⁾ t[h]: L70 / B50 @ 25 °C (Ta), t[h]: L80 / B10 @ 25 °C (Ta), t[h]: L90 / B10 @ 25 °C (Ta)

Control gear

Output current	100 mA
ECG - Output ripple current	< 30 %
ECG - Length	100 mm
ECG - Width	46 mm
ECG - Height	26,0 mm

Certificates & Standards

Standards	CE / UKCA
Luminaire with limited surface temperature, "D sign"	No

Ball shot safe	No
----------------	----













Additional product data

Added function	MULTI SELECT
----------------	--------------

EQUIPMENT / ACCESSORIES

- Already equipped with white round ring
- Additional cover rings separately available in round and square shape and in different colors

DOWNLOAD DATA

Documents and certificates		Document name
	User Instruction	UI SPOT COMBO and ACC
	Legal information	Legal Insert SPOT COMBO
	Declarations of conformity	CE Declaration SP COMBO
	Declarations Of Conformity UKCA	UKCA Declaration SP COMBO
Photometric and lighting design files		Document name
	IES file (IES)	SP CBO ADJ V 3.6W 927
	LDT file (Eulumdat)	SP CBO ADJ V 3.6W 927
	ULD file (DIALux)	SP CBO ADJ V 5.5W CPS 60DEG IP65 WT
	ROLF file (RELUX)	SPOT COMBO ADJUST V 5.5W CPS 60DEG IP65 WT
	UGR file (UGR table)	SP CBO ADJ V 3.6W 927
	LDC typ cone	SP CBO ADJ V 3.6W 927
	LDC typ polar	SP CBO ADJ V 3.6W 927
CAD/BIM files		Document name
	BIM_Revit_3D	Spot Combo

CAD/BIM files	Document name
 CAD_STEP_3D	SP CBO ADJ

LOGISTICAL DATA

Product code	Packaging unit (Pieces/Unit)	Dimensions (length x width x height)	Gross weight	Volume
4099854092725	Folding box 1	77 mm x 107 mm x 98 mm	229.00 g	0.81 dm ³
4099854092732	Shipping box 20	402 mm x 228 mm x 222 mm	4932.00 g	20.35 dm ³

The mentioned product code describes the smallest quantity unit which can be ordered. One shipping unit can contain one or more single products. When placing an order, for the quantity please enter single or multiples of a shipping unit.

ADDITIONAL CATALOG INFORMATION

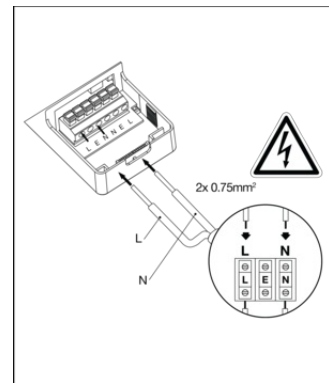
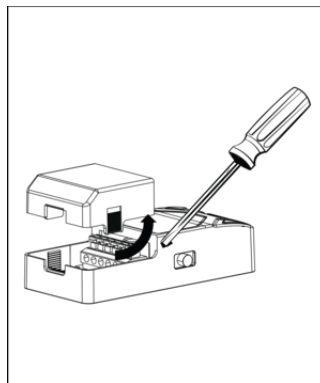
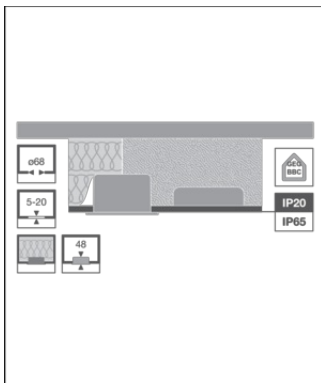

References / Links

– For Guarantee see www.ledvance.com/guarantee

DISCLAIMER

Subject to change without notice. Errors and omission excepted. Always make sure to use the most recent release.