

# PRODUCT DATASHEET

## FL PFM 125 W 4000 K SYM 100 BK

FLOODLIGHT 125 W | Versatile floodlight with up to 15000 lm light output



### Areas of application

- Replacement for floodlights with halogen lamps
- Outdoor use (IP65)
- Industry
- Public areas
- Construction areas
- Building facades

### Product benefits

- Bright, robust and durable
- Safe and very uniform illumination, due to frosted and tempered glass diffuser
- No upper light output ratio (ULOR 0%) when mounted at 0° tilt
- Energy savings of up to 90 % compared to halogen lamp floodlights
- 5 years guarantee

### Product features

- Reflector-based, symmetric light distribution with 100° x 100° beam angle
- Integrated wide voltage driver, suitable for 100 - 277 V<sub>AC</sub>
- Surge protection: up to 6 kV (L/N-PE), 4 kV (L-N)
- Mounting bracket with 30° angle and wide rotation area
- Breather membrane to optimize air exchange, without compromising IP protection
- Pre-installed, flexible 1 m cable (H05RN-F), wrapped 3 x 1.0 mm<sup>2</sup> single wires



## TECHNICAL DATA

### Electrical data

Nominal wattage	125.00 W
Nominal voltage	100...277 V
Mains frequency	50...60 Hz
Nominal current	630 mA
Inrush current	60 A
Inrush current time $T_{h50}$	1000 $\mu$ s
Max. number of luminaires per miniature circuit breaker B16	4
Max. number of luminaires per miniature circuit breaker C10	7
Max. number of luminaires per miniature circuit breaker C16	11
Power factor $\lambda$	> 0.90
Total harmonic distortion	< 20 %
Protection class	I
Operating mode	Integrated LED driver

### Photometrical data

Luminous flux	15000 lm
Luminous efficacy	120 lm/W
Color temperature	4000 K
Light color (designation)	Cool White
Color rendering index Ra	$\geq$ 80
Standard deviation of color matching	$\leq$ 5 sdc <sub>m</sub>
Luminous intensity	-
Low flicker	Yes
Flickering metric (Pst LM)	-
Stroboscope effect metric (SVM)	-
Photobiological safety group acc. to EN62778	RG1
Photobiological safety group acc. to EN62471	RG1
Beam angle	100 ° x 100 °

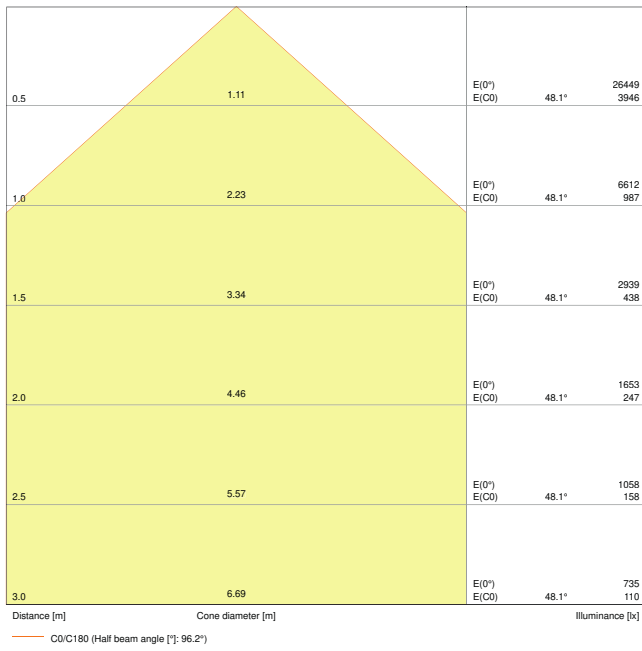

FL PFM 125W4000K SYM 100 BK

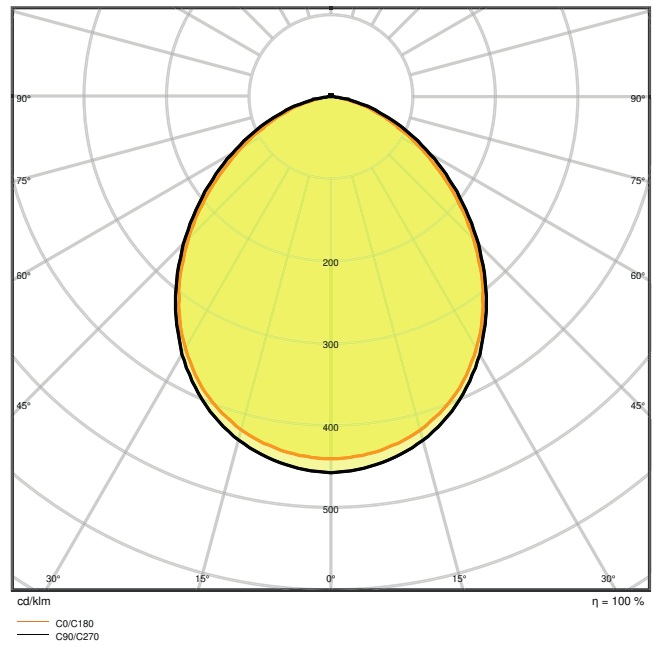

FL PFM 125W4000K SYM 100 BK

Dimensions & Weight

Length	381.00 mm
Width	290.00 mm
Height	59.00 mm
Product weight	3800.00 g
Cable length	1000 mm

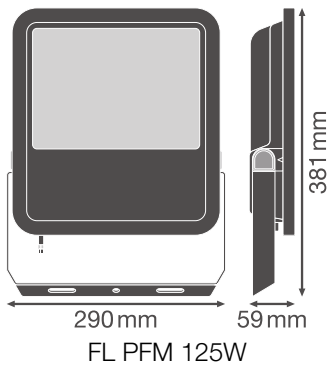

Materials & Colors

Product color	Black
Housing color	Black
Body material	Aluminum
Light emitting surface material	Glass
Glow Wire Test according to IEC 60695-2-12	650 °C
Mercury content	0.0 mg

### Application & Mounting

Ambient temperature range	-30...+50 °C
Temperature range at storage	-40...+70 °C
Type of connection	Cable, 3-pole
Type of protection	IP65
Protection class IK (shock resistance)	IK08
Dimmable	No
Mounting type	Surface
Mounting location	Wall / Pole / Floor / Ceiling
Application environment	Outdoor
Adjustable	Yes
LED module replaceable	Not replaceable
With light source	Yes

### Lifespan

Lifespan L70/B50 at 25 °C	70000 h <sup>1)</sup>
Lifespan L80/B10 at 25 °C	55000 h <sup>1)</sup>
Lifespan L90/B10 at 25 °C	35000 h
Number of switching cycles	100000

<sup>1)</sup> t[h]: L70 / B50 @ 25 °C (Ta), t[h]: L80 / B10 @ 25 °C (Ta), t[h]: L90 / B10 @ 25 °C (Ta)

### Control gear

Output current	740 mA
ECG - Output ripple current	< 35 %

### Certificates & Standards

Standards	CE / CB / ENEC / EAC / RoHS / EPD
Luminaire with limited surface temperature, "D sign"	No
Ball shot safe	No















EPD

LEDV-00017-V01.01-EN

### Safety advice

– Max. wind load surface 0.083 m<sup>2</sup>

### DOWNLOAD DATA

Documents and certificates		Document name
	User Instruction	UI FL PFM 65W - 200 W
	Addon Technical Information	LSI FL PFM SYM
	Addon Technical Information	LSI FL PFM SYM
	Legal information	Legal Insert FL PFM
	Declarations of conformity	FLOODLIGHT PFM
	Declarations Of Conformity UKCA	FL PFM SYM
Photometric and lighting design files		Document name
	IES file (IES)	FL PFM 125W4000K SYM 100 BK
	LDT file (Eulumdat)	FL PFM 125W4000K SYM 100 BK
	ULD file (DIALux)	FL PFM 125W-4000K SYM 100 BK
	ROLF file (RELUX)	FL PFM 125W-4000K SYM
	UGR file (UGR table)	FL PFM 125W4000K SYM 100 BK
	LDC typ cone	FL PFM 125W4000K SYM 100 BK
	LDC typ polar	FL PFM 125W4000K SYM 100 BK
CAD/BIM files		Document name
	BIM_Revit_3D	Floodlight G3

CAD/BIM files		Document name
	CAD_STEP_3D	FL G3 125W

---

Tender texts		Document name
	Tender documents	FLOODLIGHT 125 W 4000 K SYM 100 BK-EN



**LOGISTICAL DATA**

Product code	Packaging unit (Pieces/Unit)	Dimensions (length x width x height)	Gross weight	Volume
4058075423701	Shipping box 1	343 mm x 92 mm x 443 mm	4305.00 g	13.98 dm <sup>3</sup>

The mentioned product code describes the smallest quantity unit which can be ordered. One shipping unit can contain one or more single products. When placing an order, for the quantity please enter single or multiples of a shipping unit.

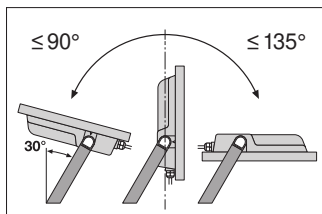
**ADDITIONAL CATALOG INFORMATION**



	A	B	C		
65 W	150	108	8.5	2x M8	0,046 m <sup>3</sup>
80 W	150	108	10,5	2x M10	0,061 m <sup>3</sup>
125 W	170	118	10,5	2x M10	0,083 m <sup>3</sup>
165 W	170	118	12,5	2x M12	0,102 m <sup>3</sup>
200 W	170	118	12,5	2x M12	0,124 m <sup>3</sup>

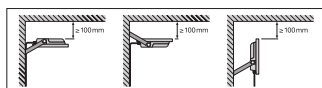
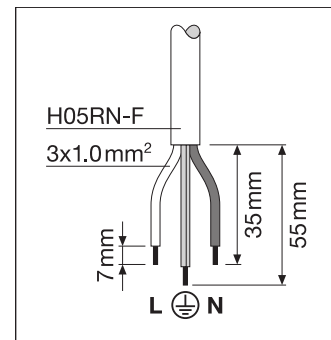

**References / Links**

– For Guarantee see [www.ledvance.com/guarantee](http://www.ledvance.com/guarantee)

**DISCLAIMER**

Subject to change without notice. Errors and omission excepted. Always make sure to use the most recent release.